

Seminář Java

Základy objektové orientace III

Radek Kočí

Fakulta informačních technologií VUT

Únor 2008

- Technika návrhu
- Demonstrační příklad

Zadání:

Vytvořte aplikaci s GUI pro hanoiské věže.

Ilustrační příklad

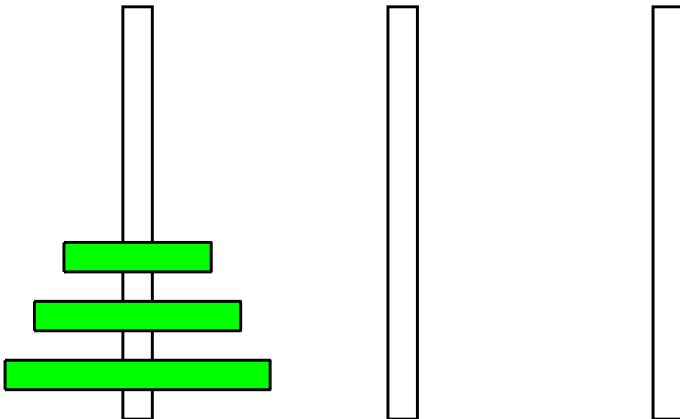

Ilustrační příklad

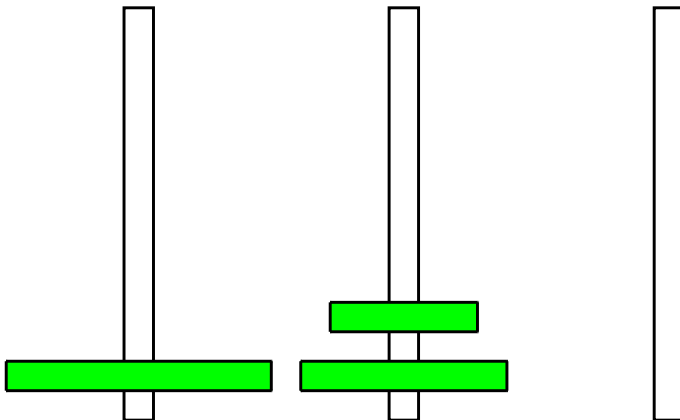

Ilustrační příklad

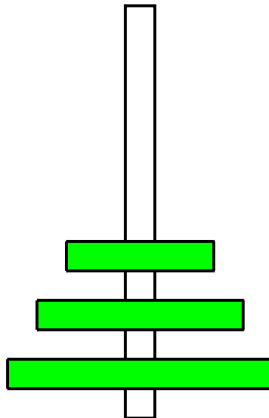

Analýza – Objektový diagram

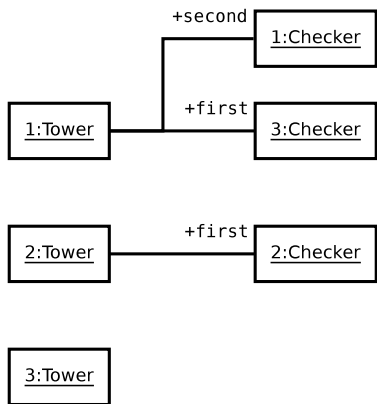
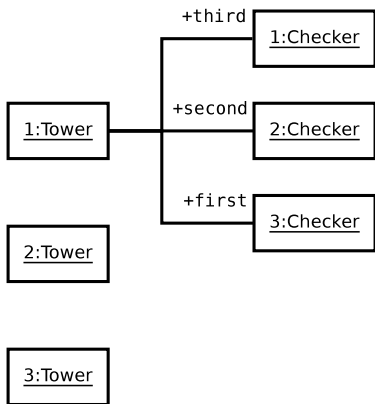



Analýza – Diagram tříd

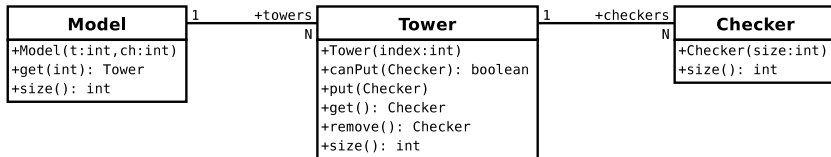

Analýza – Diagram tříd

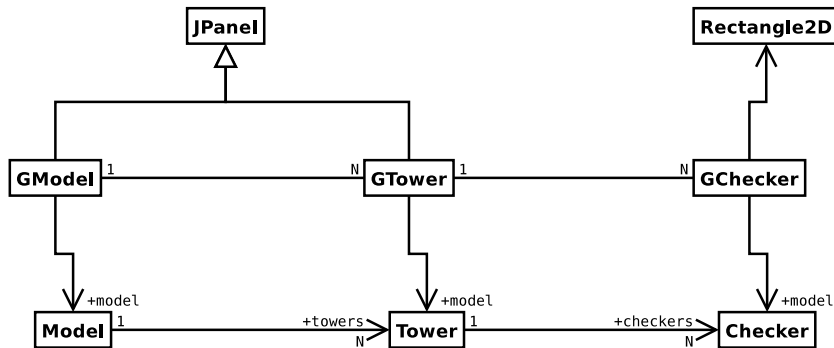

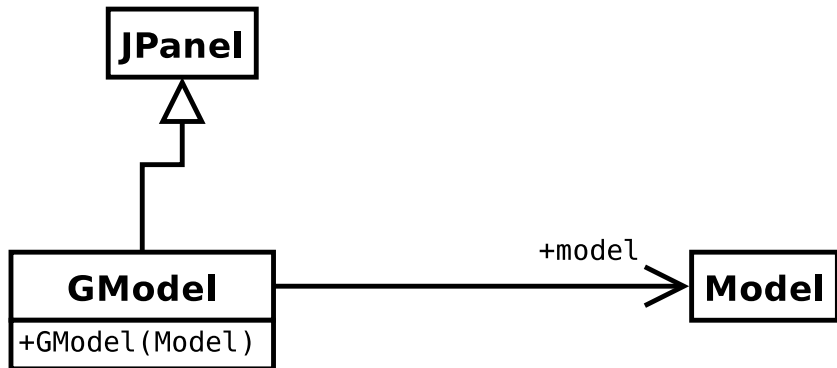

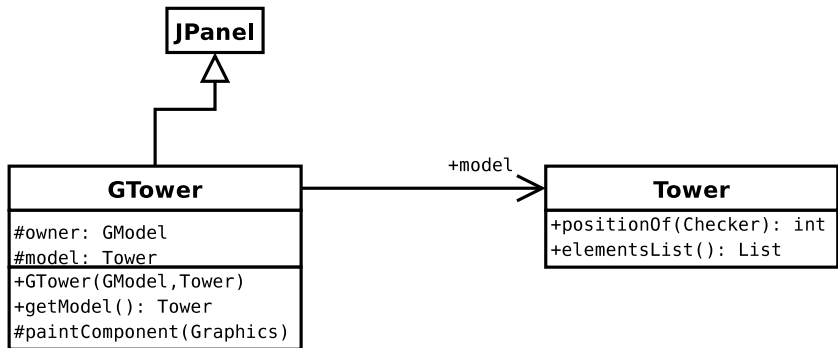

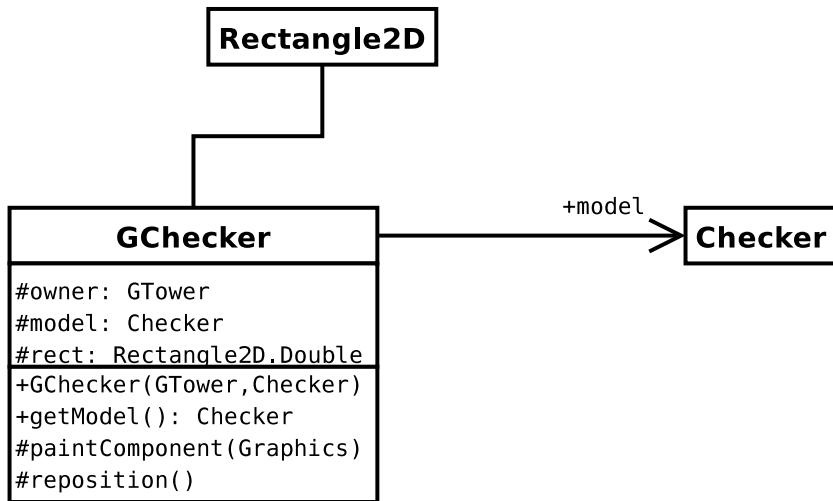

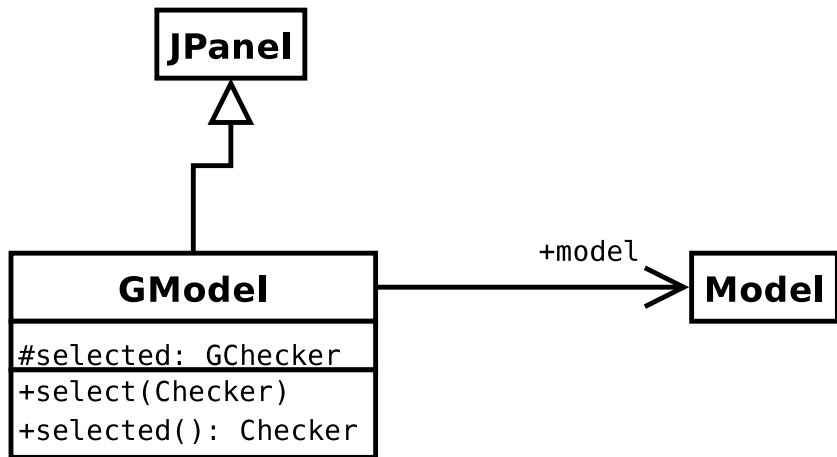

Analýza – Diagram tříd

